

MHF[®] Plug Cable Assembly

Mating Profile : **2.5mm MAX.**

Applicable for various cable gauge

[Part Number]

Ground Contact : **Au** Plating

Ground Contact : **Ag** Plating

20278-1 * 2 R- * *

20308-1 * 2 R- * *

① ② ③

① ② ③

①	Tool	0	for Hand Tool (with Notch)
		1	for Semi-Auto (without Notch)
②	Packing	R	Reel 1reel : 2,000pcs
③	Applicable Cable Size	-	P/N 20278 : 08, 13, 32, 18 P/N 20308 : 13, 32

[Applicable Cable gauge]

Part No. (Au)	20278-1*2R-08	20278-1*2R-13	20278-1*2R-32	20278-1*2R-18
Part No. (Ag)	-	20308-1*2R-13	20308-1*2R-32	-
	for AWG#36	for AWG#32	for AWG#32	for AWG#30
Braided Shield of Outer Conductor	Single Braided Shield	Single Braided Shield	Double Braided Shield	Single Braided Shield RG178 B/U

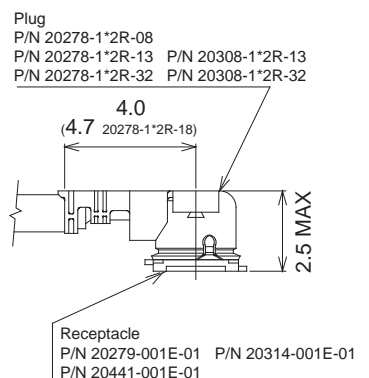
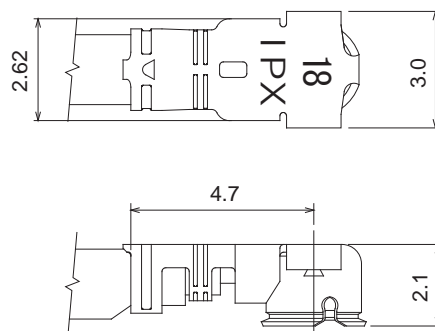
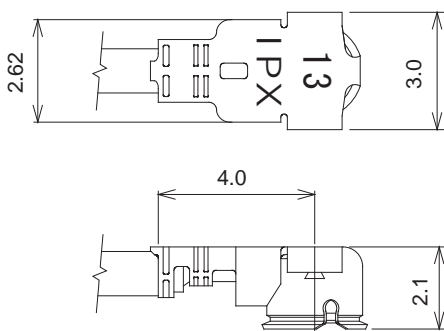

[Material and Finish]

MATED VIEW

Parts	Material	Plating / Color	Note
HOUSING	PBT UL94V-0	NATURAL or BLACK	Only Au 08, Au 18 is NATURAL
CONTACT	COPPER ALLOY	Au	
GROUND CONTACT	COPPER ALLOY	Au or Ag	

MHF[®] Receptacle

3pad type

[Part Number]

Ground Contact : **Au** Plating

20279-001 E- * *

① ②

Ground Contact : **Ag** Plating

20314-001 E- 01

①

①	Packing : Emboss Tape		
②	1reel	01	2,500pcs
		03	5,000pcs

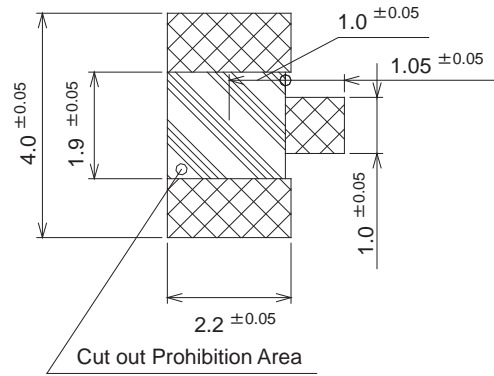
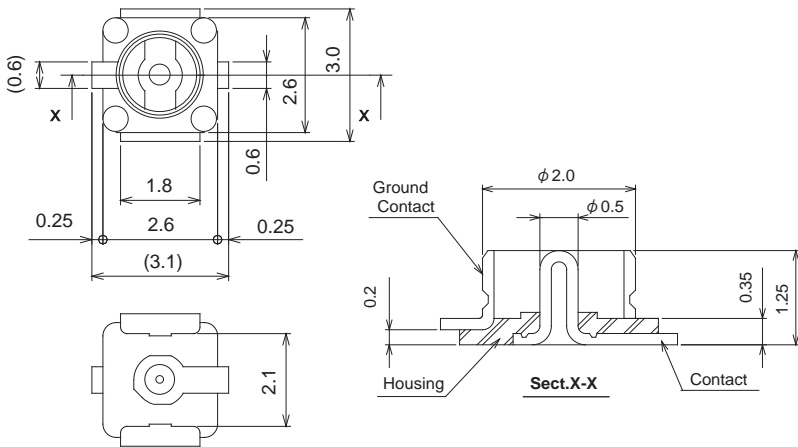

RECOMMENDED FOOTPRINT PATTERN

4pad type

[Part Number]

Ground Contact : **Au** Plating

20441-001 E- 01

※

※ Packing : Emboss Tape

1reel : 5,000pcs

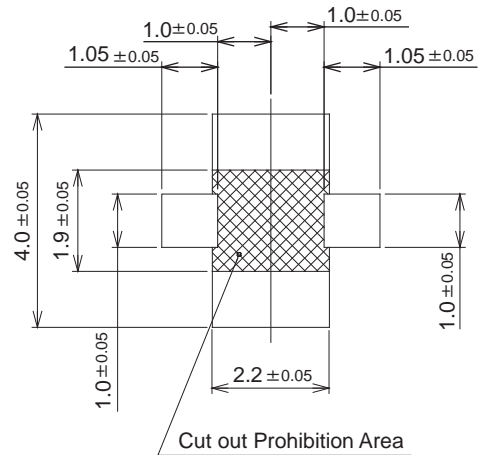
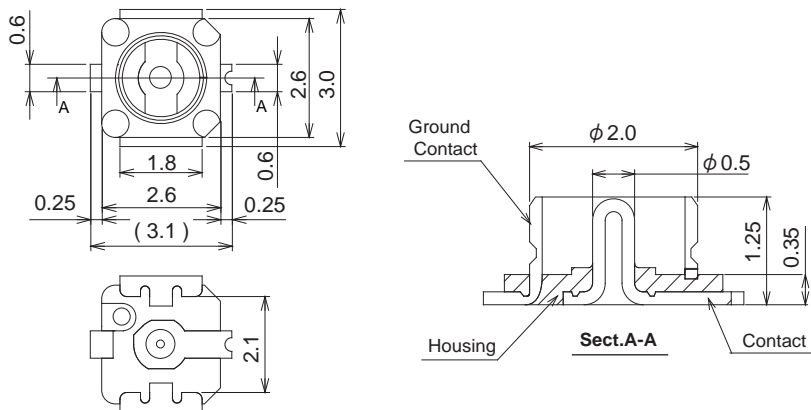

RECOMMENDED FOOTPRINT PATTERN

[Material and Finish]

Parts	Material	Plating / Color (3pad)	Plating / Color (4pad)
HOUSING	LCP UL94V-0	NATURAL	BLACK
CONTACT	COPPER ALLOY	Au	Au
GROUND CONTACT	COPPER ALLOY	Au or Ag	Au